

The Art Light Series

"Precision Picture Framing & Gobo Projection"

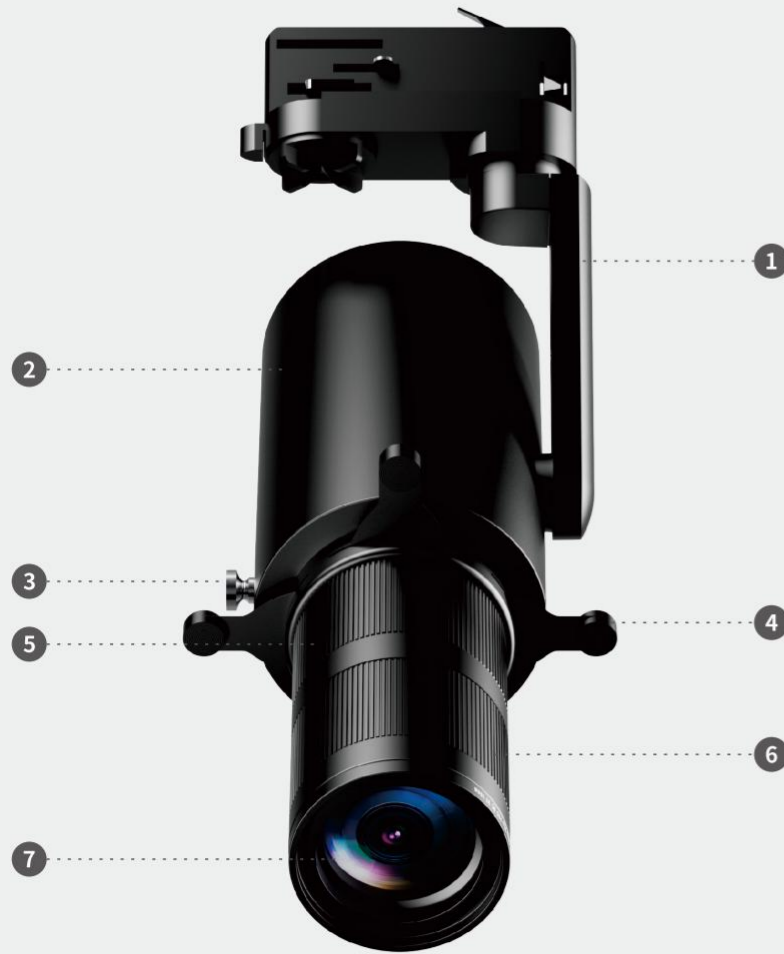

lamp structure



1- Holder

Support 355 degree rotation, the beam angle can be adjusted freely.

2-Cold forging integrated heat dissipation

The lamp body is made by 1070 High purity aluminium, and adopt the integrally-formed technology to ensure the good heat dissipation and protect the whole lamp.

3-Spot hand regulator

Hand release screw to realize the function of 355 degree rotation.

4-Optical adjustable aperture plates

The spot shape can be arbitrarily changed by adjusting the aperture plates

5-Zoom damping knob

Rotate it can change the size of spot

6-Focus damping knob

Rotate it can change the acutance of spot

7-High quality coated optical lenses

It can increase light transmittance, reduce the distortion, eliminate the blue ray.

lens characteristics



professional-grade optical lens

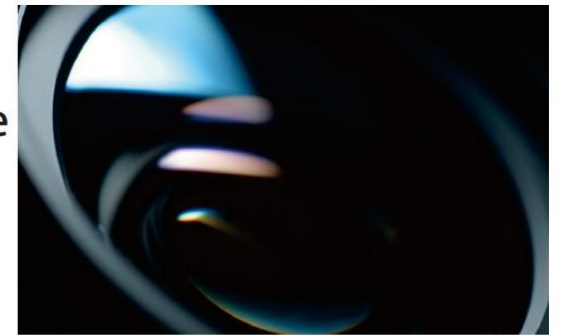

precision-grade parts

- Multiple optical design patents
No distortion, uniform spot, high-definition projection
- Mechanical damping structure patent
No damping grease required, Very stable



Professional-grade lens

Multiple coated lens elements, precision cutting, uniform spot, high light output efficiency, low distortion. Make your paintings look vividly lifelike!



Circle



Trapezoid



Irregular shape

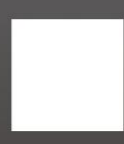

Square



Rhombus



Triangle



Industrial Grade Optical Filter

Lens can be matched with a variety of industrial grade optical filters, can be customized special narrow band, extremely narrow band optical filters. Some filter functions can be superimposed, such as: HD UV+ Color filter, HD UV+ Soft light filter and so on.

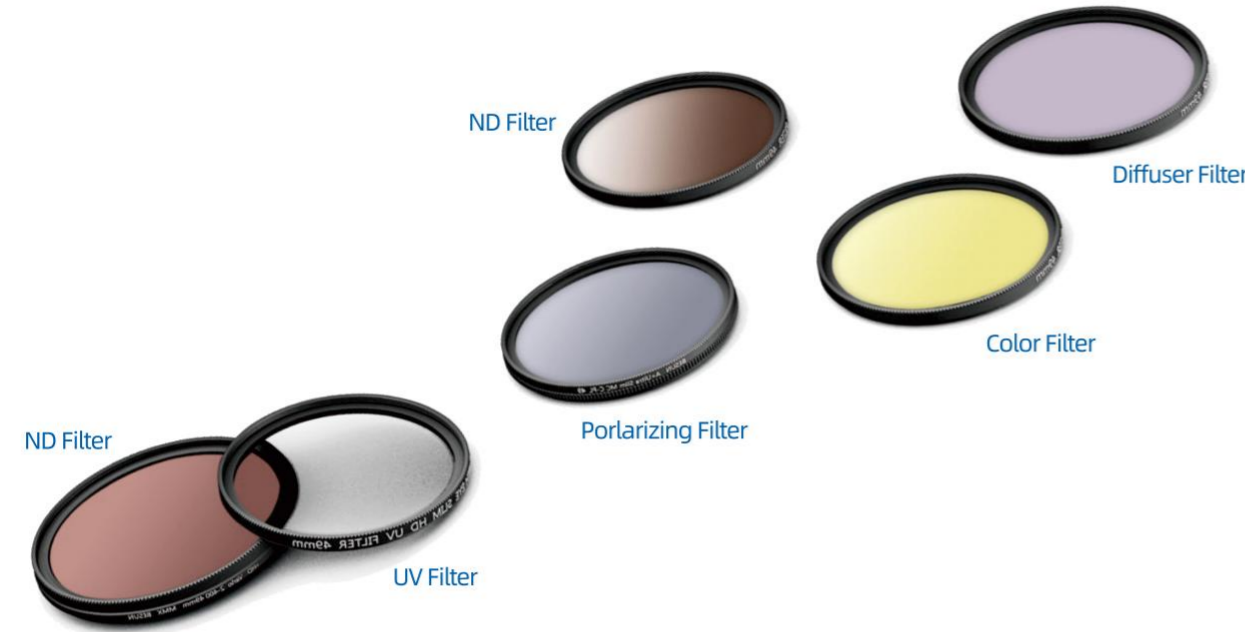

Polarizing Filter: can eliminate the reflection on the surface of the object, so that the object shows the original appearance in the over-bright environment.



Color Filter: You can freely change the color of the light.



Dimming Filter: With electronic dimming, small Angle illumination can be adjusted to less than 75 lux for authentic display.



Used in special occasions, such as: circuit board printing, medicine, chemical sorting, etc.



Diffuser Filter: can make the light more soft.



UV Filter: can filter the ultraviolet light in the lamps, and protect the cultural relics.



Color Gradient Filter: makes the light have different color change effects. The medium gray gradient mirror makes the light have different brightness, and the uniform layer.

Projection Function



Physical Landscape Projection



Logo Icon Projection



Star Sky Projection



Marketing Projection



Delicious Food Projection

VG Series

- Mechanical damping structure patent

No damping grease required, Very stable

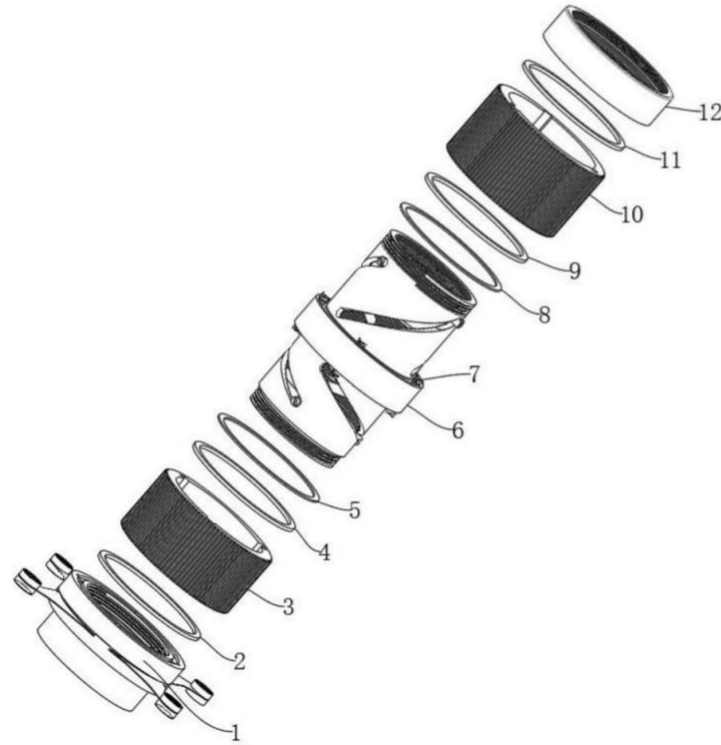

- Zoom Series

Zoom angle range 20°-35°/25°-40°/50°-60°

Low distortion

Standard clarity projection



VG Series

GHSVG4510-2035

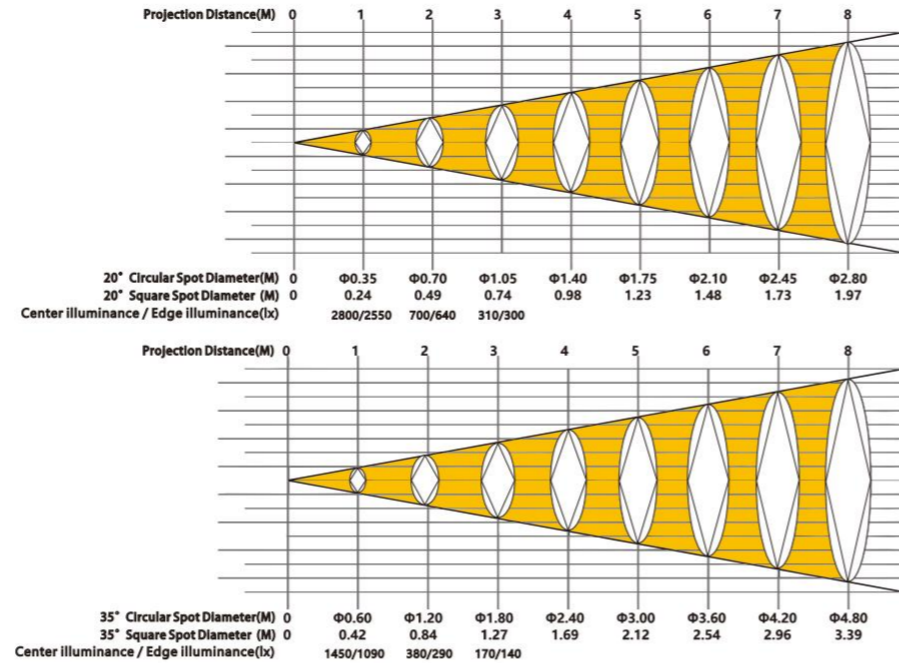

Power	Luminous Flux	CRI	CCT	Beam Angle	DIP CCT	Dimming	Smart Control	G.W	Filter Specification	Color
10W	300-350LM	Ra≥95	2700K/3000K/4000K	20°-35°	Support	Support	Support	400g	37mm	Black/White



VG Series

GHSVG4510-2035P

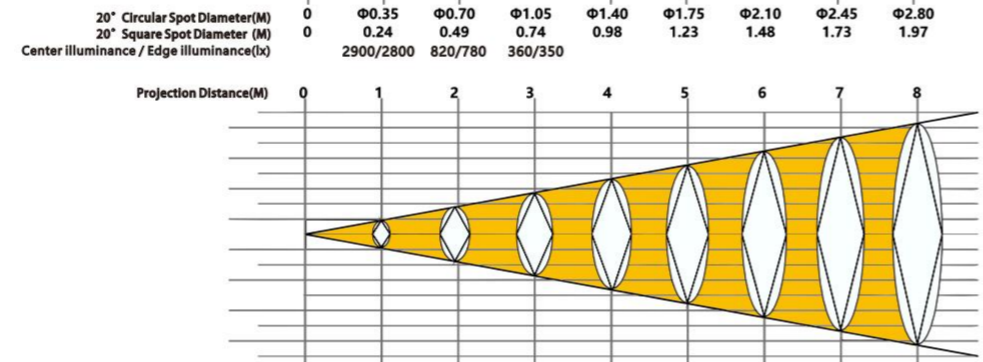
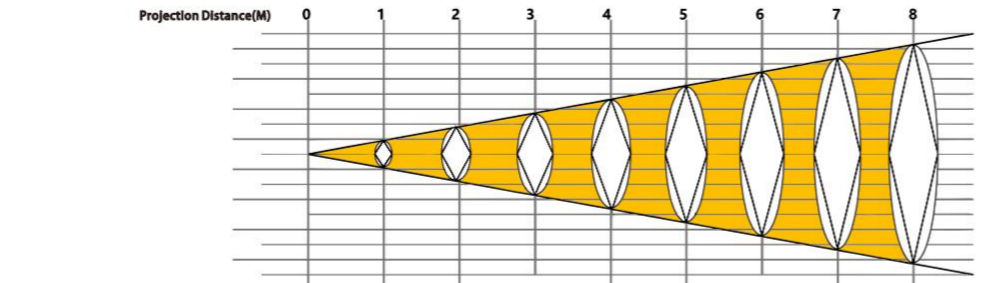

Power	Luminous Flux	CRI	CCT	Beam Angle	DIP CCT	Dimming	Smart Control	G.W	Filter Specification	Color
10W	300-350LM	Ra≥95	2700K/3000K/4000K	20°-35°	Support	Support	Support	430g	37mm	Black/White



VG Series

GHSVG4510-2035R

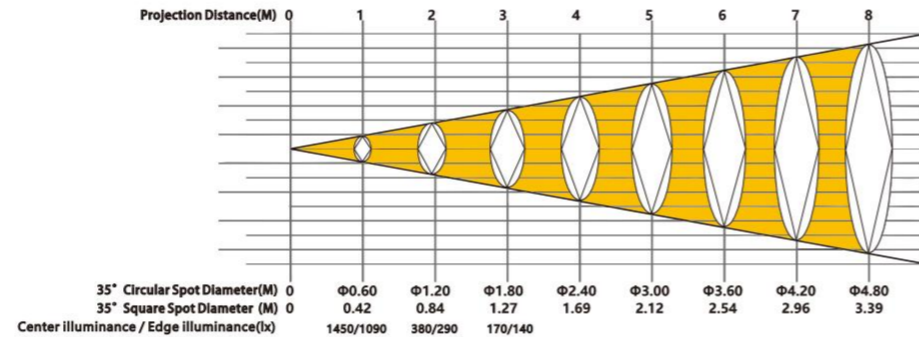
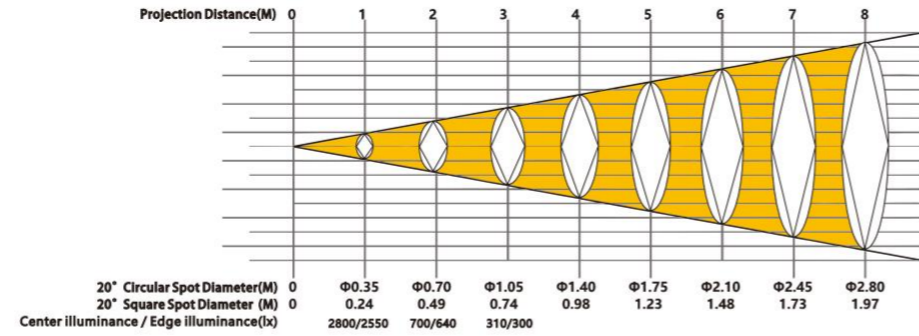

Power	Luminous Flux	CRI	CCT	Beam Angle	DIP CCT	Dimming	Smart Control	G.W	Filter Specification	Color
10W	300-350LM	Ra≥95	2700K/3000K/4000K	20°-35°	Support	Support	Support	450g	37mm	Black/White



VG Series

GHSVG4510-2035RP

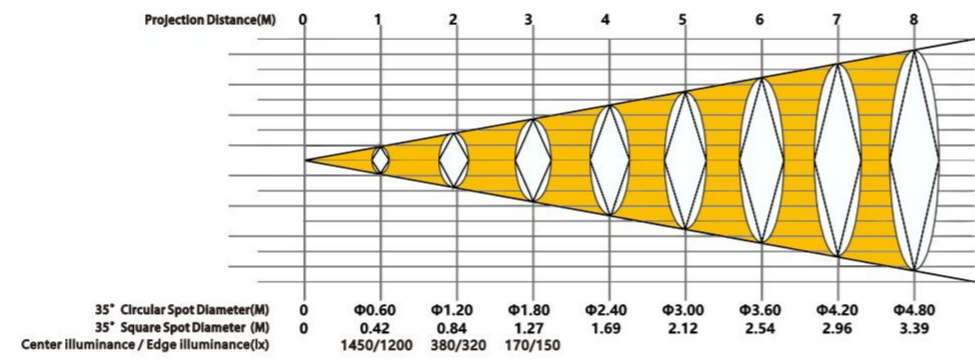
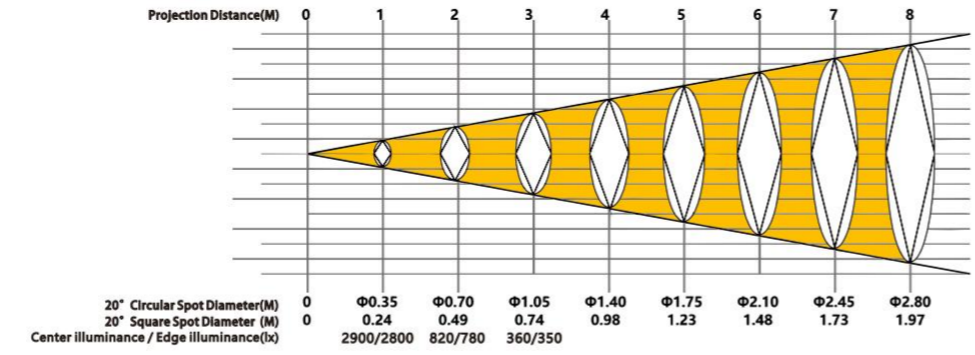

Power	Luminous Flux	CRI	CCT	Beam Angle	DIP CCT	Dimming	Smart Control	G.W	Filter Specification	Color
10W	300-350LM	Ra≥95	2700K/3000K/4000K	20°-35°	Support	Support	Support	450g	37mm	Black/White

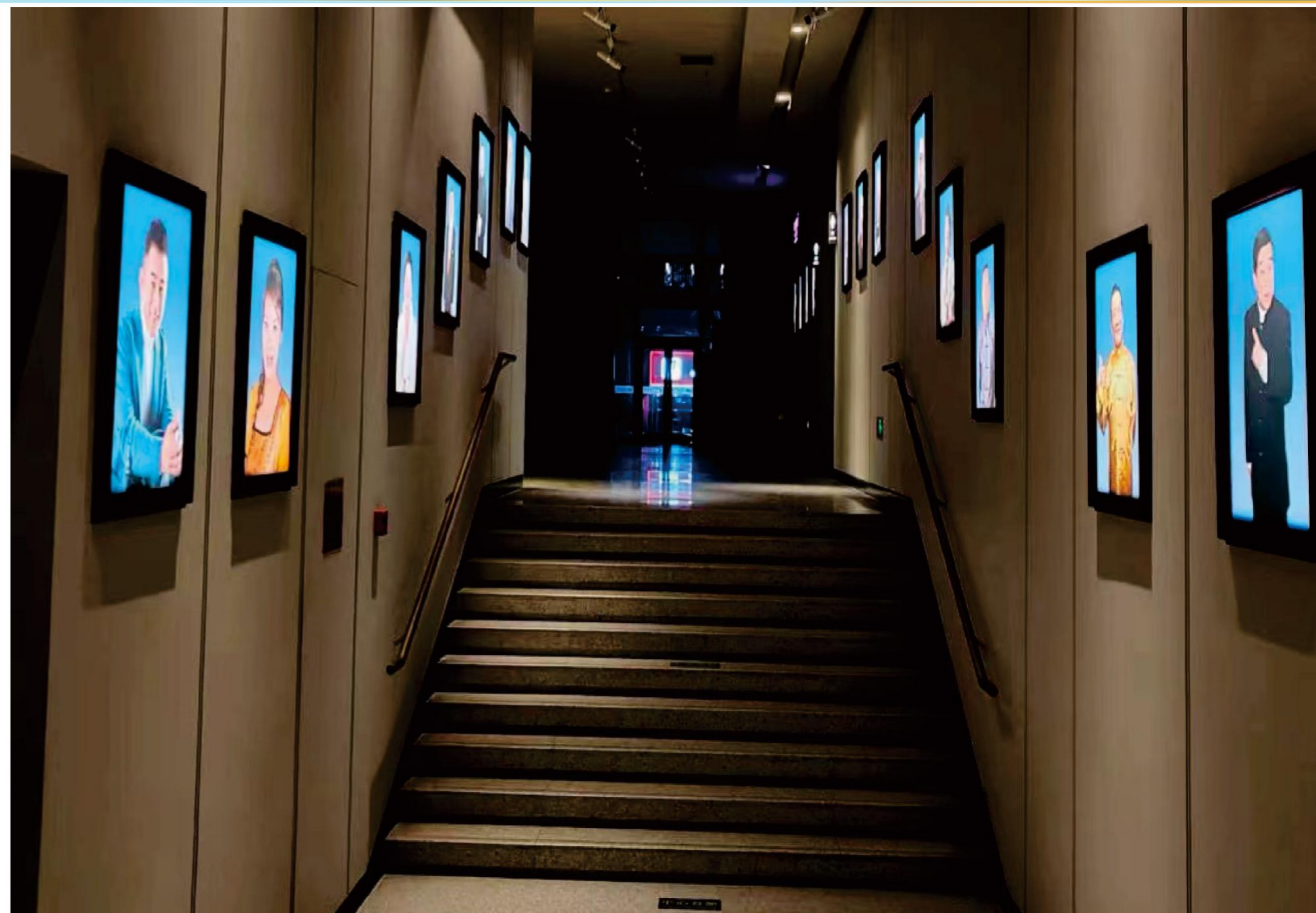

VG Series

GHSVG5015-2035P

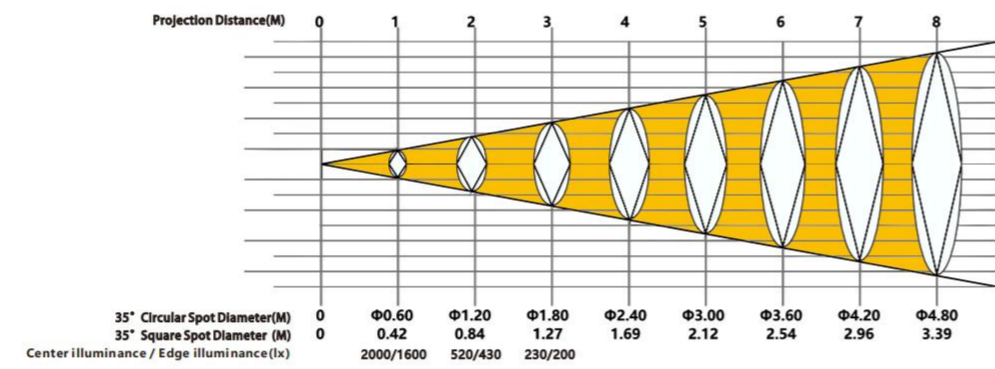
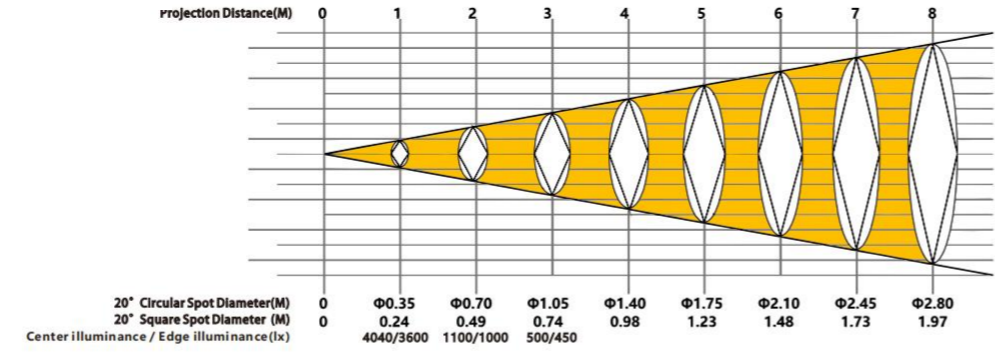

Power	Luminous Flux	CRI	CCT	Beam Angle	DIP CCT	Dimming	Smart Control	G.W	Filter Specification	Color
15W	450-500LM	Ra≥95	2700K/3000K/4000K	20°-35°	Support	Support	Support	550g	37mm	Black/White



VG Series

GHSVGMIX20-2035

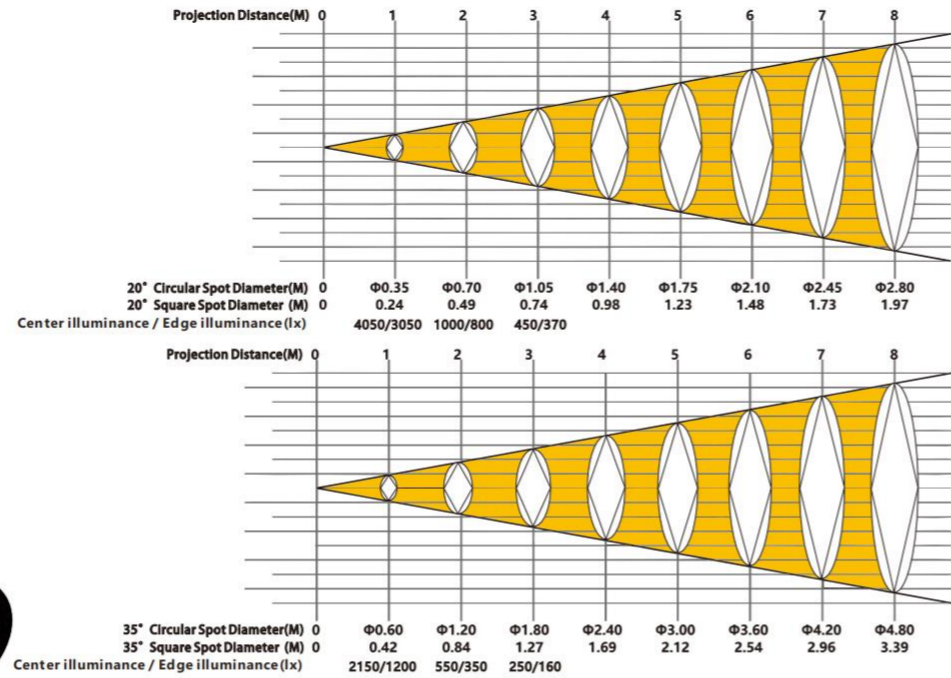

Power	Luminous Flux	CRI	CCT	Beam Angle	DIP CCT	Dimming	Smart Control	G.W	Filter Specification	Color
20W	600-700LM	Ra≥95	2700K/3000K/4000K	20°-35°	Support	Support	Support	610g	37mm	Black/White



VG Series

GHSVG8530-2540

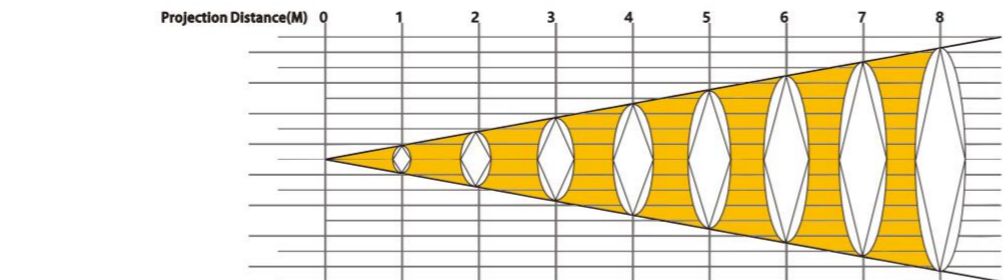

Projection Distance(M)	0	1	2	3	4	5	6	7	8
40° Circular Spot Diameter(M)	0	Φ0.72	Φ1.44	Φ2.16	Φ2.88	Φ3.60	Φ4.32	Φ5.04	Φ5.76
40° Square Spot Diameter (M)	0	0.50	1.01	1.52	2.03	2.54	3.05	3.56	4.07
Center illuminance / Edge illuminance(lx)		4000/2200	1100/620	500/300					

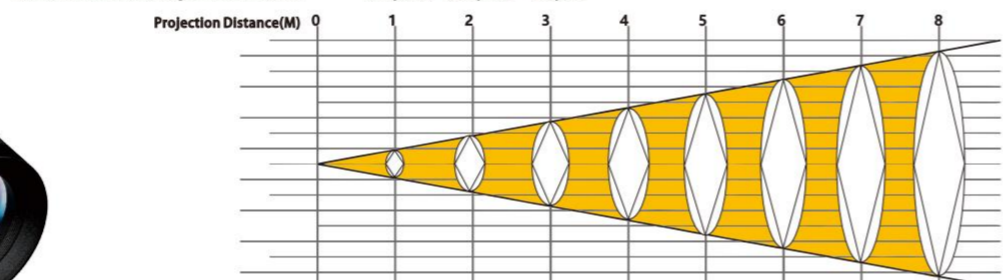

Projection Distance(M)	0	1	2	3	4	5	6	7	8
40° Circular Spot Diameter(M)	0	Φ0.72	Φ1.44	Φ2.16	Φ2.88	Φ3.60	Φ4.32	Φ5.04	Φ5.76
40° Square Spot Diameter (M)	0	0.50	1.01	1.52	2.03	2.54	3.05	3.56	4.07
Center illuminance / Edge illuminance(lx)		4000/2200	1100/620	500/300					



Power	Luminous Flux	CRI	CCT	Beam Angle	DIP CCT	Dimming	Smart Control	G.W	Filter Specification	Color
30W	1000-1100LM	Ra≥95	2700K/3000K/4000K	25°-40°	Support	Support	Support	1400g	58mm	Black/White



VG Series

GHSVG8530-5060

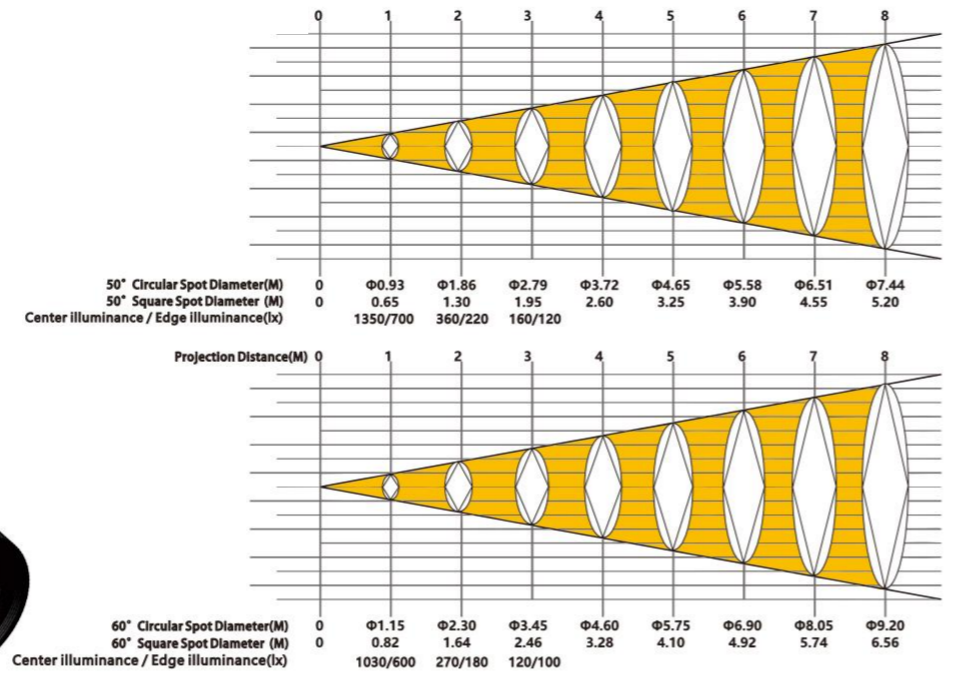

Power	Luminous Flux	CRI	CCT	Beam Angle	DIP CCT	Dimming	Smart Control	G.W	Filter Specification	Color
35W	550-650LM	Ra≥95	2700K/3000K/4000K	50°-60°	Support	Support	Support	1150g	55mm	Black/White

