

WTC-Bridge User Manual



Contents

WTC-Bridge User Manual	1
What is WTC-Bridge.....	2
Getting started with WTC-Bridge	2
Basic Configuration of the WTC-Bridge	3
Setting House Number and Geographic Location	3
Setting the Time and Date	4
Using WTC-Bridge with Rasoft Software	4
WTC-Bridge Events	5
Using the Web Interface with WTC-Bridge Events.....	5
Using Rasoft with WTC-Bridge Events	6
WTC-Bridge Mapping	7
Triggering Macros from Maps	8
WTC-Bridge Macros.....	9
An example Macro.....	10
Interfacing Smart Phones to Rako System using WTC-Bridge.....	11
Equipment List:.....	11
• Step 1: Connect the Bridge to the router.....	11
• Step 2: Set the Bridge to the same House ID number as your Rako system.....	11
• Step 3: Upload Room and Scene information to the Bridge.	12
• Step 4: Use RAKO Smart Phone application to control the lighting system.....	12
Holiday Mode	13
Holiday Mode Recording	13
Holiday Mode Playback	13
Monitor Mode	14
Sonos Control	14
WTC-Bridge Firmware Upgrades	15
Appendix 1: How to discover House and room numbers by looking at wall plates.....	16
Appendix 2: Configuring a Rasoft file to work with Smart Phone	17

What is WTC-Bridge

WTC-Bridge will add the following features to a RAKO wired system:

- **Ethernet interface**, including remote control via Smart Phone.
- **Wireless Operation**. Use Rako Wireless modules in conjunction with wired system.
- **Timed Events**. Automatic functions at fixed times or triggered by dawn & dusk times.
- **Mapping**. Commands from wall controllers can be redirected to perform other tasks.
- **Macros**. Complex series of commands that are triggered by a single command or event.
- **Holiday Mode**. Replays recorded scene activity, creating an occupied look to a property.
- **Monitor**. Diagnostic display of system activity.

Getting started with WTC-Bridge

Some initial setup of WTC-Bridge is needed.

- First, Plug the White RJ11 cable from the WTC-Bridge into RJ11 socket on a RAK-Link or RAK-Star unit and apply power. The WTC-Bridge display will light up and there will be a short beep.
- Plug the Ethernet patch cable from the WTC-Bridge to a spare port on a wireless router.
- Use a normal web browser (eg Internet Explorer) to connect to the WTC-Bridge via the router.



Use a laptop to connect to the WTC-Bridge

The default WTC-Bridge URL is <http://rakobridge>

Or

<http://rakobridge.local>

Use a Web Browser to view the WTC Bridge control panel.

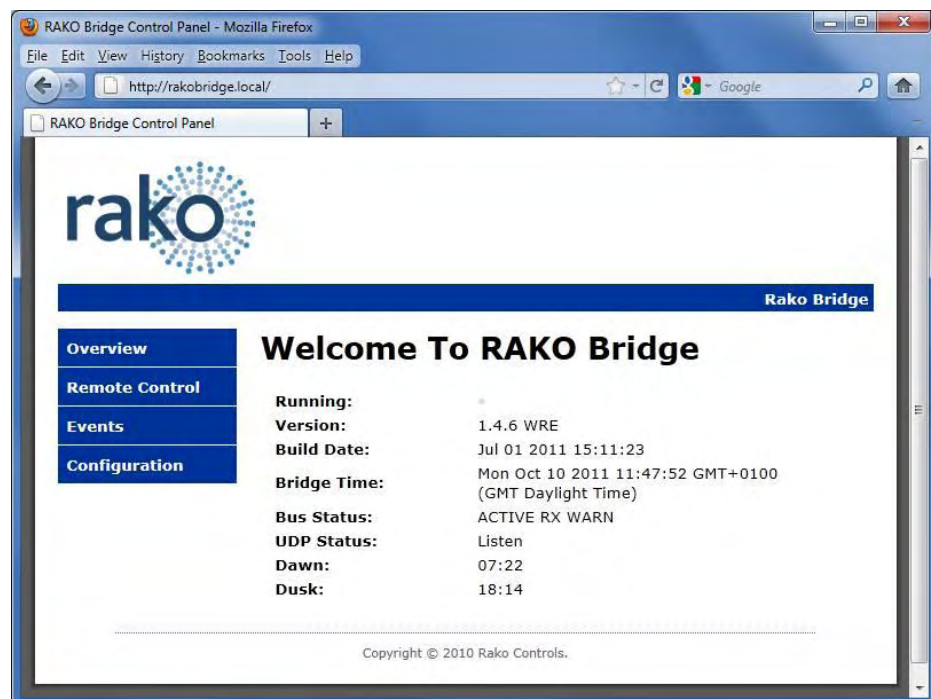

Basic Configuration of the WTC-Bridge

Setting House Number and Geographic Location

Click the *Configuration* button on the WTC-Bridge control panel.

Login
User Name = *admin*
Password = *microchip*

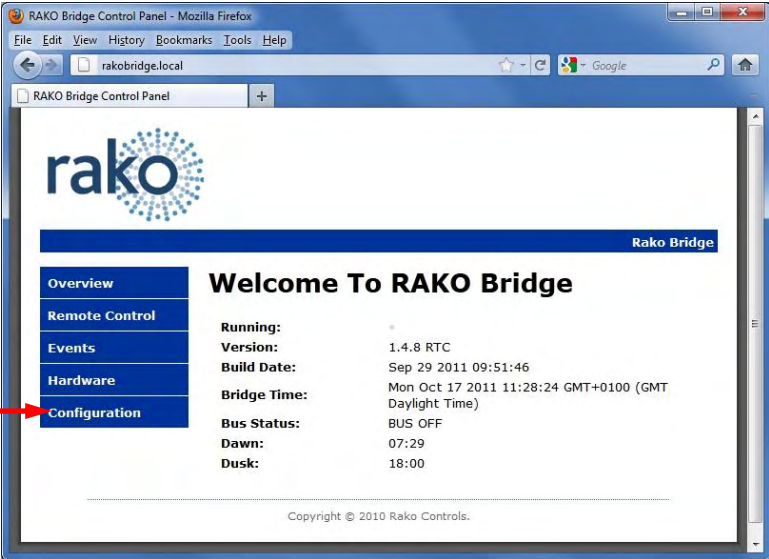

The Rako Bridge Configuration screen allows several settings to be changed. The most important are highlighted below.

Change WTC-Bridge House address

(The House Address must match the rest of the Rako Wireless system)

If there is more than One Bridge (of any type) connected to a Rako Wired system then they must be set to different Device numbers. (1,2,3 etc)

Set location

Correct location and time zone must be entered so that Bridge can calculate times for Dawn and Dusk. In South East England the default settings UTC 0, Latitude 51 and Longitude 0 are correct

Save Config

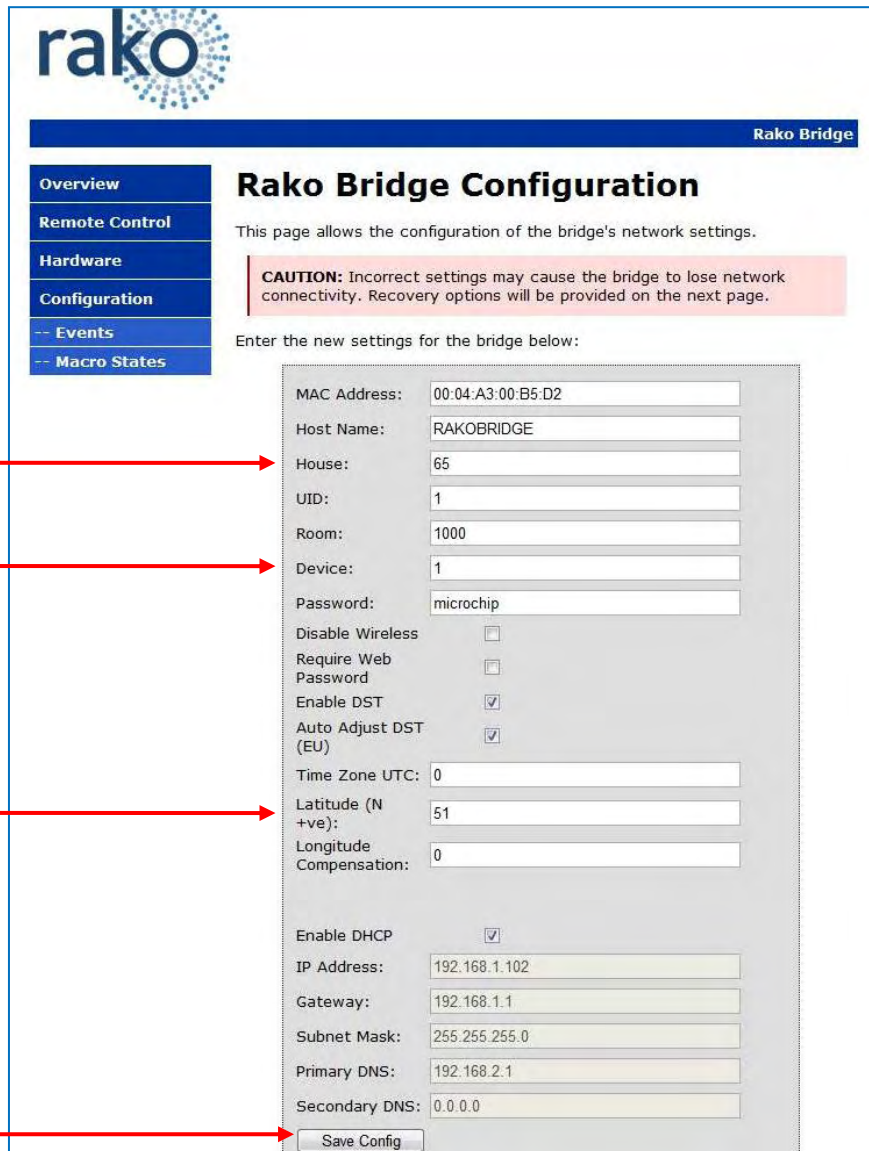

Setting the Time and Date

The WTC-Bridge Display shows current Date and Time Information. This can be set manually by pressing the buttons on the front of the WTC-Bridge.

Normally WTC-Bridge will be connected by RJ45 lead to a router. If this router is connected to Internet then the time will normally automatically update.

WTC-Bridge also has battery backed up Real Time Clock to prevent loss of time setting due to loss of power etc.

Using WTC-Bridge with Rasoft Software

Use Rasoft Software with WTC-Bridge to program a Rako Wireless system and the WTC-Bridge itself.

On the laptop, Run Rako Lighting RASOFT program. After a short delay the Rasoft start up screen will be displayed.

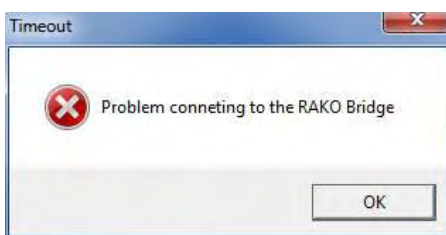

If a Timeout error occurs then click OK. The Rasoft start up screen will appear shortly. Go to the Rasoft *Controls - Communication* screen. The *Communication* Check boxes should be set like this for RASOFT to find Bridge easily. Then Quit and Restart Rasoft so that an error free startup of Rasoft occurs.

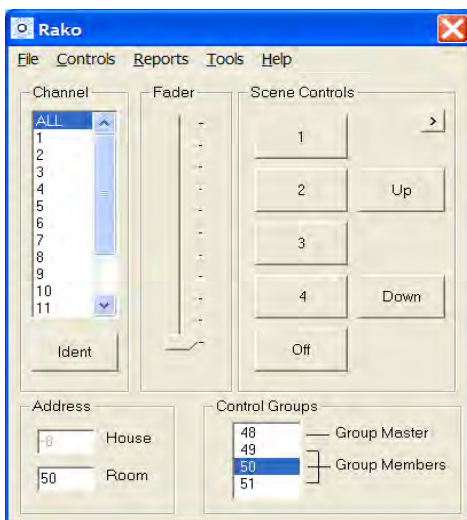

Rasoft start up screen

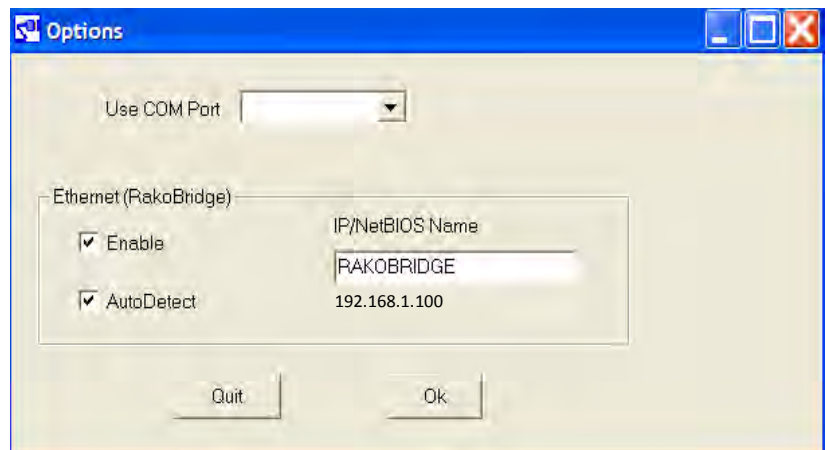

If Rasoft is communicating with the WTC-Bridge Correctly then it will display an IP address below the IP/NetBios Name.

Tip: It can take a minute or two from connecting the bridge to the router & switching it on, before RASOFT is able to talk to it .

Tip: Do not have any Rako USB or RS232 devices connected to your computer as these will interfere with the Bridge setup process

WTC-Bridge Events

The WTC-Bridge can generate automated Events that occur at specific times.

As an example; the WTC-Bridge can be programmed to make garden lighting be switched On at Dusk and Off at midnight each day.

Events can be viewed, added and changed by using the WTC-Bridge Web Interface, or by using the RASOFT program.

Using the Web Interface with WTC-Bridge Events

Access the WTC-Bridge Events Screen from the Configuration screen

This example shows an Event which sets Scene 1 in Room 4 at 9:20 AM on weekdays.

List of Events stored in the WTC-Bridge. Events 1,2,3 are active. The screen is currently displaying Event 1

Store the Event in WTC-Bridge by pressing *Update Event*

Test the Event by pressing *Trigger Event*

rako

Rako Bridge

Overview

Remote Control

Hardware

Configuration

Events

Macro States

Events

Event Trigger

Active

Dawn

Dusk

Time

Hours

Minutes

Active Days

Monday

Tuesday

Wednesday

Thursday

Friday

Saturday

Sunday

All Weekdays Weekends

Action

Room

Channel:

Type

Scene:

Default Fade rate:

Actions

Update Event Trigger Event

ID: 1 Active

ID: 2 Active

ID: 3 Active

ID: 4 Inactive

ID: 5 Inactive

ID: 6 Inactive

ID: 7 Inactive

ID: 8 Inactive

ID: 9 Inactive

ID: 10 Inactive

Trigger Dawn

Trigger Dusk

Dawn/Dusk trigger for all events

Using Rasoft with WTC-Bridge Events

WTC-Bridge Events can also be viewed and edited using RASOFT software.

The WTC-Bridge Events Screen is located under *Controls-Bridge-Events*

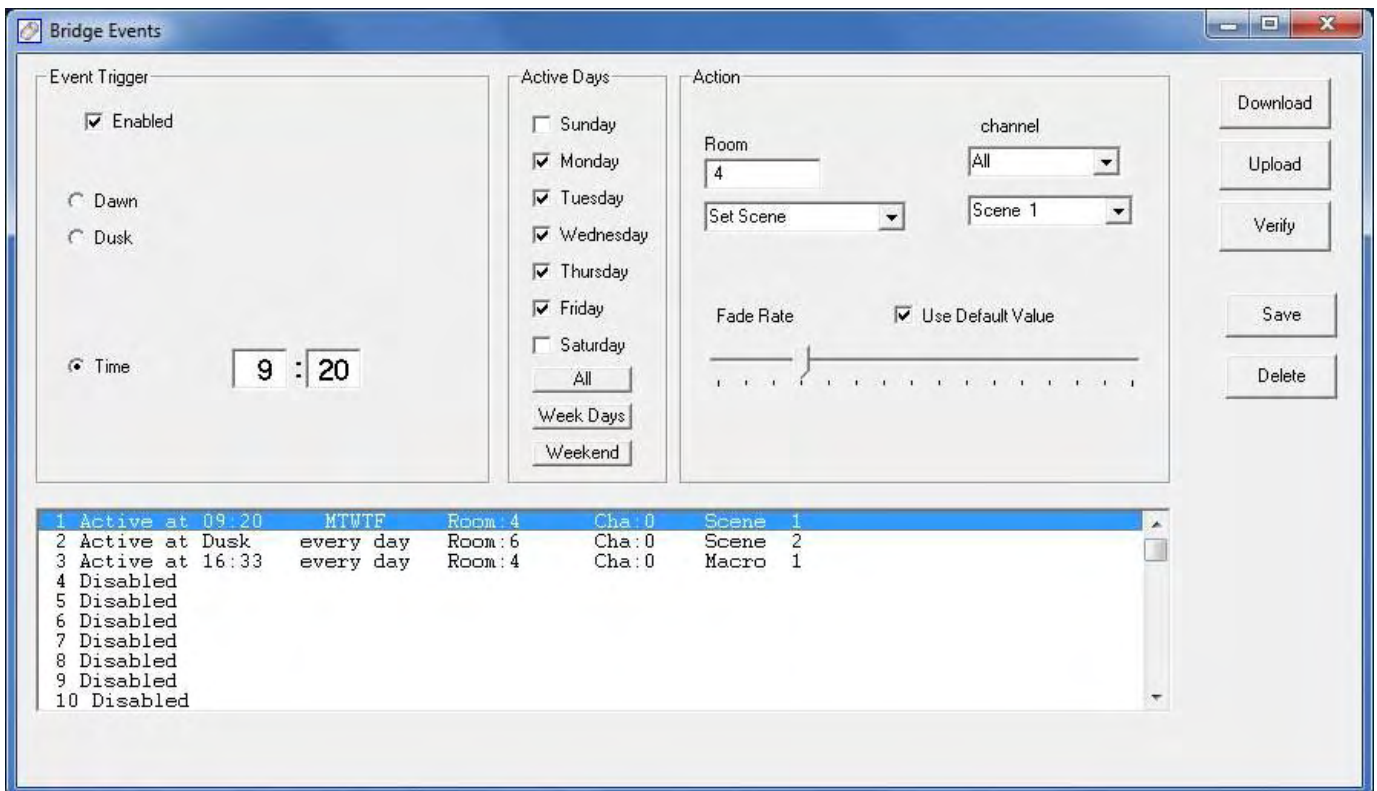

This Bridge Events screen is displaying the same Example Event as previously which sets Scene 1 in Room 4 at 9.20AM on weekdays.

To add or edit an Event, simply highlight it from the list at the bottom part of the window. Make sure the *Event Trigger* is *Enabled*. Set up the Event as required then press the *Save* button.

The *Upload* button must be used to write Events from Rasoft to the WTC-Bridge. This will overwrite any events that are already in the WTC-Bridge.

The *Download* button is used to read Events already stored in the WTC-Bridge back into Rasoft. This will overwrite any events that are already in Rasoft.

The *Verify* button can be used to check that the Events in Rasoft and those in the WTC-Bridge match with each other.

WTC-Bridge Mapping

WTC-Bridge Mapping screen is located at *Controls-Bridge-Mapping*

When Mapping is used the WTC-Bridge will listen to the Rako Commands sent by Wall Controllers, Smart Phones, Hand Held remotes etc . When the WTC-Bridge hears a command that matches one of its Maps it will perform a specified Action.

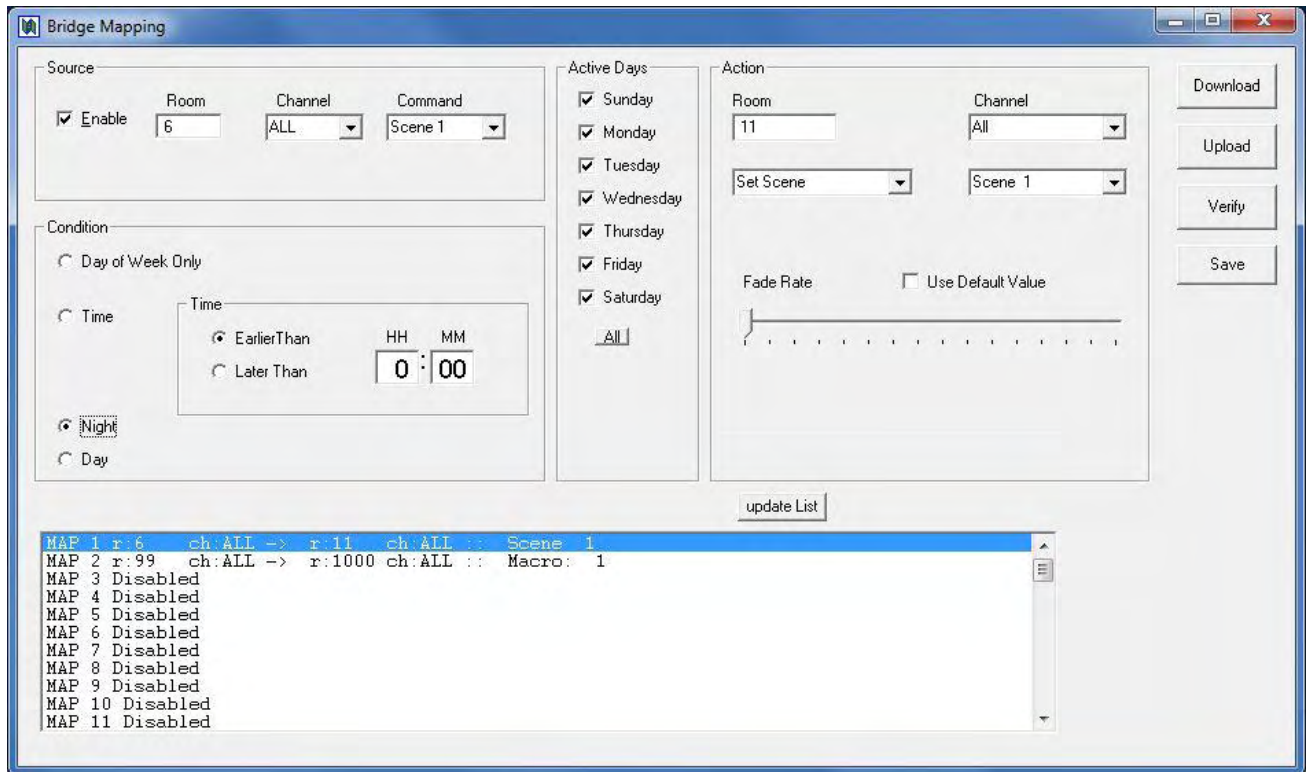

In the example above the WTC-Bridge has two Maps programmed. Map 1 is being displayed. When a Room 6, Scene 1 Command is received the WTC-Bridge will transmit a Room 11, Scene 1 command. This particular Map is active on all days of the week, but only operates at Night. The *fade rate* slider and check box can be used to change how quickly the Wired dimmers fade to the new scene. This feature does not apply to wireless dimmers.

The *Upload* button must be used to write Mappings from Rasoft to the WTC-Bridge. This will overwrite any Mappings that are already in the WTC-Bridge.

The *Download* button is used to read Mappings already stored in the WTC-Bridge back into Rasoft. This will overwrite any Mappings that are already in Rasoft.

The *Verify* button can be used to check that the Mappings in Rasoft and those in the WTC-Bridge match with each other.

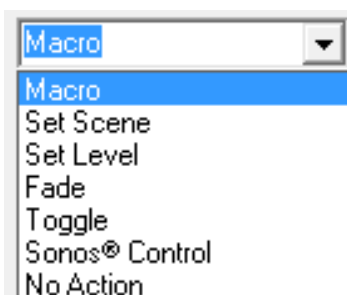

Maps do not have to simply translate one Scenes simply into another scene.

Maps can trigger a variety of Actions as shown here

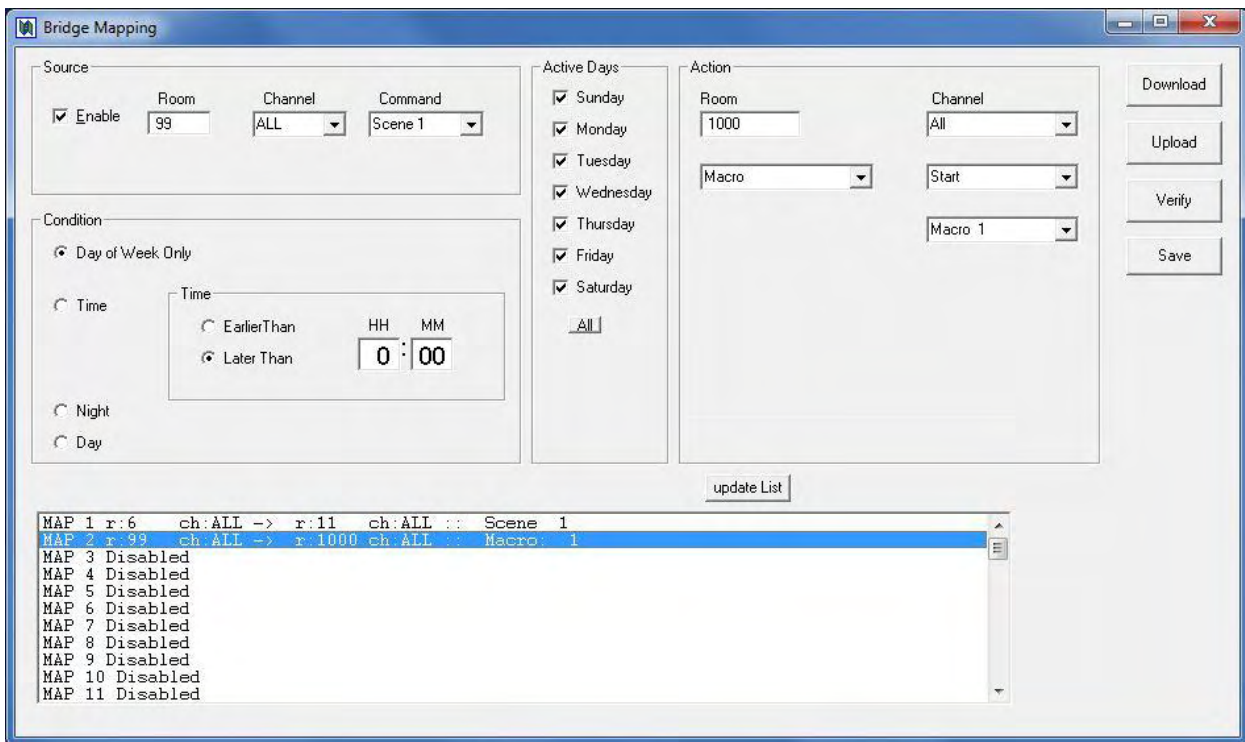

Map 2 in this example shows how a scene command (Room 99, Scene 1) can start a Macro. This Map is active at any time on any day of the week.

(The Room Number 1000 refers to the WTC-Bridge Room number as set in the Rako Bridge Configuration web page)

Triggering Macros from Maps

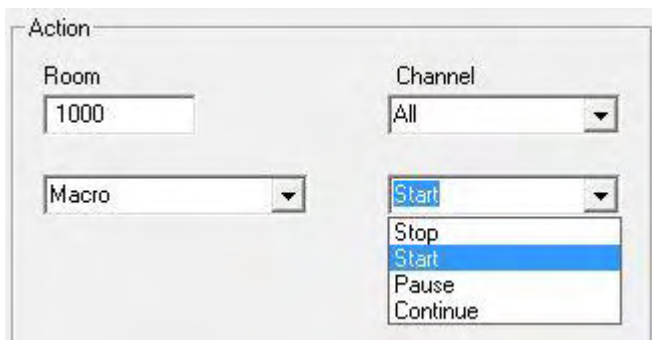

A Map can trigger a Macro in several ways:

- **Start** will cause the Macro to start from the beginning.
- **Stop** will cause a Macro that is already running to cease (and return to the beginning).
- **Pause** will cause a Macro to Pause at whatever step it is currently running.
- **Continue** will cause the Macro to continue from a Paused state, performing the next step.

WTC-Bridge Macros

Macros allow a sequence of actions to take place when triggered by an Event or Map

The WTC-Bridge Macro screen is located at *Controls-Bridge-Macros*

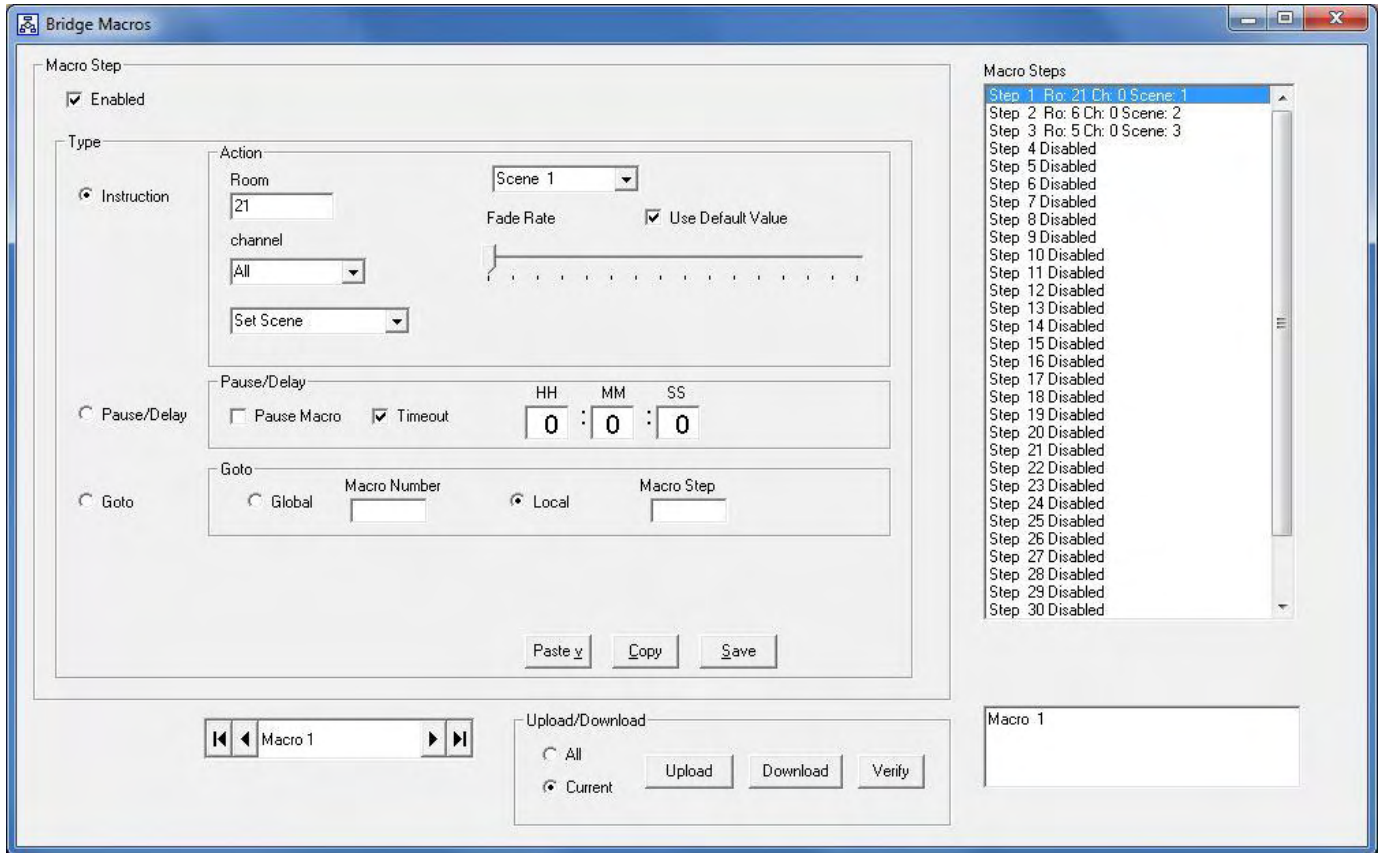

WTC-Bridge can store up to 64 Macros. This example shows Macro 1. There are 3 steps to the Macro, each of which is a simple Scene Command.

Each Macro step can be one of 3 types

- Instruction: Can be one of the types shown to the right

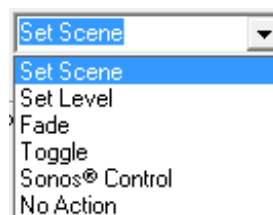

- Pause/Delay: The Macro can pause for a time delay, or can pause until it is retriggered by a Map
- Goto: The Macro can jump to another step in the Macro (usually back to the beginning), or can jump to a different Macro.

An example Macro

Macro that performs a toggle function



Consider this Macro. When it is started it will transmit a Room 1 Scene 1 command. It will then Pause at Step 2 and remain there until the Macro is retriggered.

If the Macro is triggered to *continue*, it will move to step 3

All the step after step 3 are disabled. Scrolling down to the end of the Macro reveals that all Macros have an implicit *Pause* and *Goto Step 1* at their ends.

So, after running step 3 the Macro will pause at the end.

If Macro is then triggered again to *continue* it will go back to step 1.



Thus this Macro performs a toggle function between Scene 1 and Off – Each time it receives a *continue* it will toggle the scene on or off.

HOWEVER – There is a problem with this Macro!

When a Wallplate transmits a scene command it repeats the message 3 times to increase the wireless system reliability. With this type of Macro the macro will trigger on reception of the first wallplate transmission. The Macro will finish before the last wallplate transmission is received. This causes a second triggering of the Macro. The result is that that the toggle does not work.

The correct form for this Macro is:

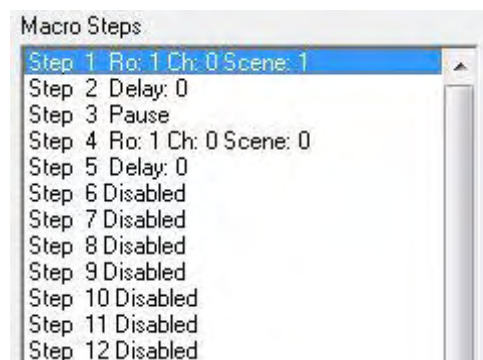

Delays have added to slow the Macro down. Even though these delays have zero value they make enough difference to prevent the Macro running too quickly.

Interfacing Smart Phones to Rako System using WTC-Bridge

Equipment List:

- A Wired RAKO lighting system.
- A WTC-Bridge.
- A Smart Phone (Android or Iphone), IPad or IPod Touch
- A Wireless network (with spare router Ethernet connector).
- A PC with the supplied RASOFT software installed (version 2.2.7 or later).
- The RASOFT Configuration file for the house. (The person who commissioned the lighting system should be able to provide this) If this is not available, then see appendix 1 to create one.

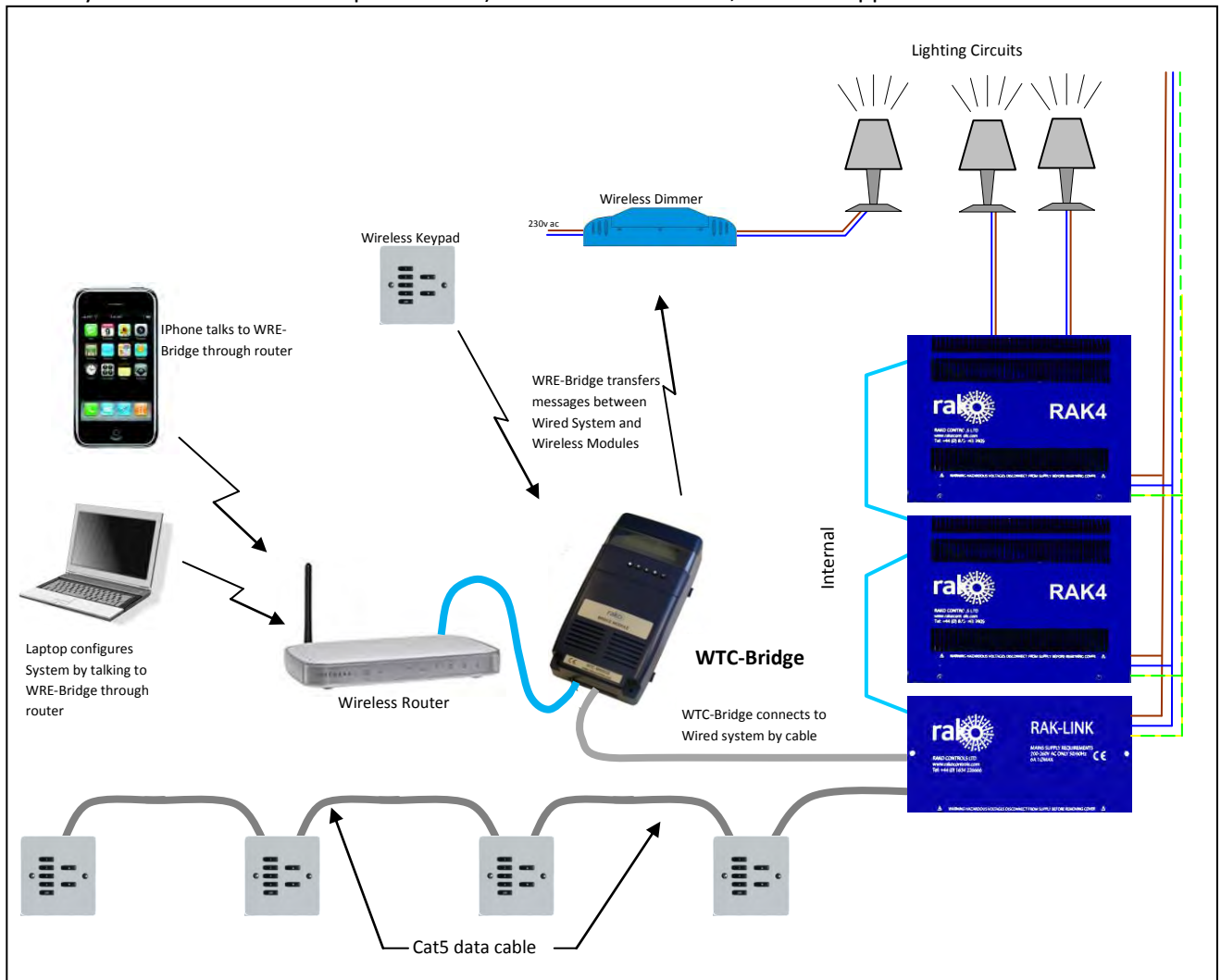

• Step 1: Connect the Bridge to the router.

See the previous section "[Getting Started with WTC-Bridge](#)".

• Step 2: Set the Bridge to the same House ID number as your Rako system.

Every RAKO wireless system has a House ID number between 1 and 255. It is necessary to tell the Bridge what house ID number has been set so that it talks to the correct house (and not the neighbours!). If the House number is unknown look at the DIP switches settings on the rear of the lighting control wall plates and decode the house ID number from those.

Use Web Browser to set correct House number as shown in previous section "[Setting House Number & Geographic location](#)" Appendix 1 shows how to decode the wall plate switch settings.

- **Step 3: Upload Room and Scene information to the Bridge.**

The Bridge needs to be told about how the RAKO system has been configured. This is done by using the RASOFT program (version 2.2.7 or later) combined with the RASOFT Configuration file that was used to set the system up.

Open the configuration file for the house's RAKO system:

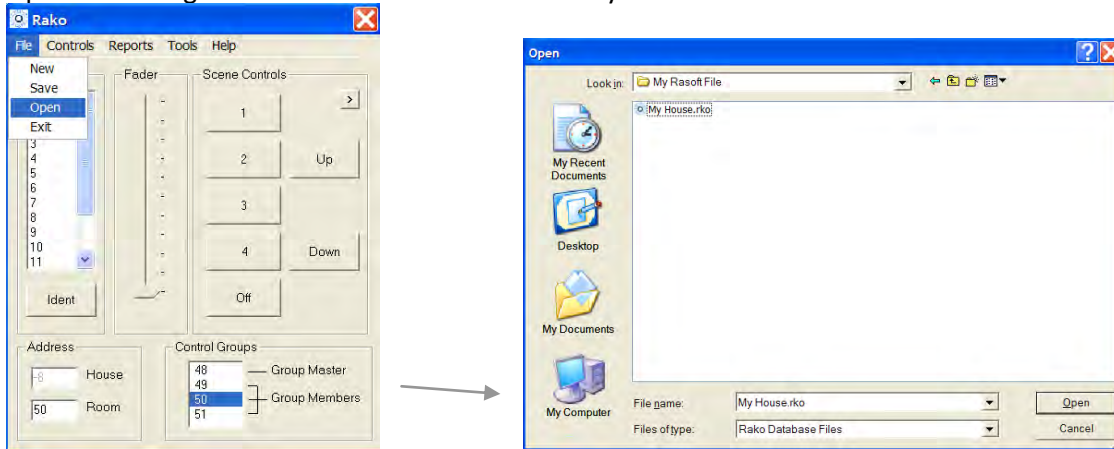

If the RASOFT configuration is not available, then refer to appendix 2 to create one.

When the Configuration File is successfully loaded:

Open the **Bridge Setup** menu item.

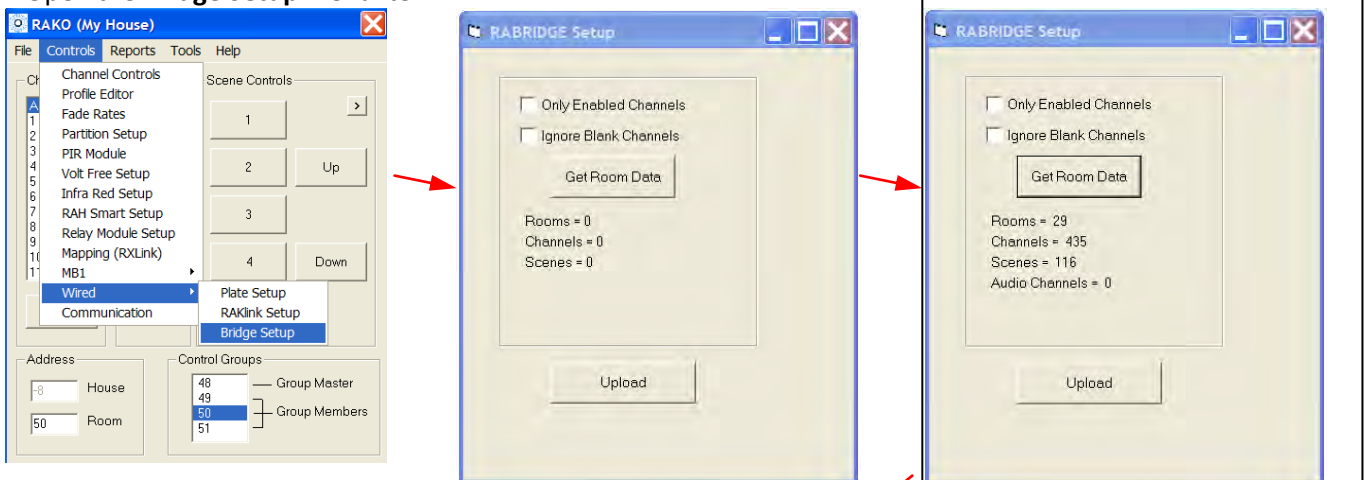

Click on **Get Room Data....**

and a number of Rooms, channels etc appear.

Now just click on **Upload** to transfer the Room data to the Bridge. Should take a few moments to complete.

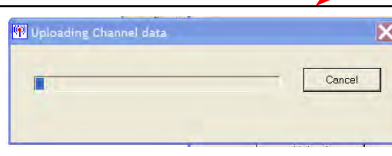

TIP:
For best results tick either the "Only Enabled Channels" or "Ignore Blank Channels" check box.

- **Step 4: Use RAKO Smart Phone application to control the lighting system.**

Make sure the Phone is able to connect to the router.

Download the RAKO application from the app store.

Run the application. The phone will find the WTC-Bridge after a few moments.

The Rako application will display the room and scene information that has been uploaded t



Holiday Mode

Holiday mode allows the WTC-Bridge to record normal lighting activity in a property over a period. This can then be replayed whilst the property is empty in order to give a realistic impression that it is occupied.

Holiday Mode Recording

The WTC-Bridge must record activity for a period of at least 24 hours before the Holiday Mode can be used.

Use the buttons on the front of the WTC-Bridge.

To start Record:

Press the circle button until *Holiday* is displayed.

Press the Tick button until *Holiday – Start Record* is displayed.

Press the Tick button so that *Holiday Record* is displayed.

After a few seconds the display will revert to showing the current date and time. A Flashing “R” symbol at the right hand side of the display indicates that the unit is in Holiday Record mode

Holiday Mode Playback

The WTC-Bridge must record activity for at least 24 hours before Playback can be enabled.

Use the buttons on the front of the WTC-Bridge

To start Playback:

- Press the Circle button until *Holiday Idle* is displayed
- Press the Tick button until *Holiday Idle – Replay* is displayed
- Press the Tick button so that *Holiday Replay* is displayed

After a few seconds the display will revert to showing the current date and time. A Flashing “H” symbol at the right hand side of the display indicates that the unit is in Holiday Replay mode



Monitor Mode

In Monitor Mode the WTC-Bridge display will show the last Rako Command that has been received. This is a very useful diagnostic tool.

The monitor display can display the commands in two ways: Either as Decoded Instructions, or as Raw Data. Most users will be interested in Decoded Instructions.

To enable Monitor Mode:

- Press the Circle button until *Monitor* is displayed.
- Press the Tick button so that either *Monitor-Raw* or *Monitor-decode* is displayed

The WTC-Bridge will now display any commands received.

Note – only Commands for the same House Number as set in the WTC-Bridge are shown. Commands from other House Numbers are ignored.



Y R065 C000 I049
Scene 2

Decoded display

Room 65

Channel 0

Scene 2

Source = Wireless Wallplate



U IP R006 C000 I049
Scene 1

Decoded display

Room 6

Channel 0

Scene 1

Source = Smart Phone

Sonos Control

WTC-Bridge can be used to enable control of a Sonos Wireless HiFi Audio System from the Rako. This requires upgrade of WTC-Bridge using additional ACM plug in module.

WTC-Bridge Firmware Upgrades

Periodically WTC-Firmware updates are posted on Rako Website.

The Rasoft software will scan for these updates automatically when it has web access.

To check for Firmware Update in Rasoft go to *Controls-Wired-Bridge-Setup*

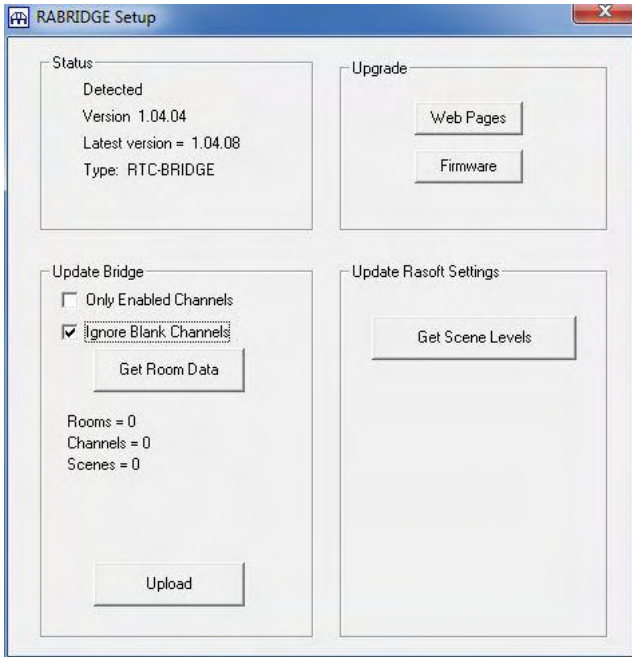

Bridge Setup screen shows the Current version of Bridge firmware and latest version available.

To Upgrade the firmware press the *Firmware* button.

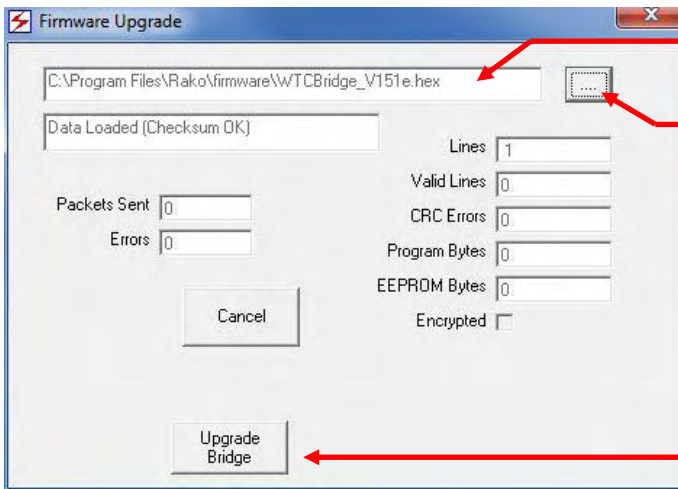

Text box shows new Firmware file to send to bridge

Button for manual selection of Firmware Upgrade file – refer to Rako Tech support

Button to start the Upgrade process

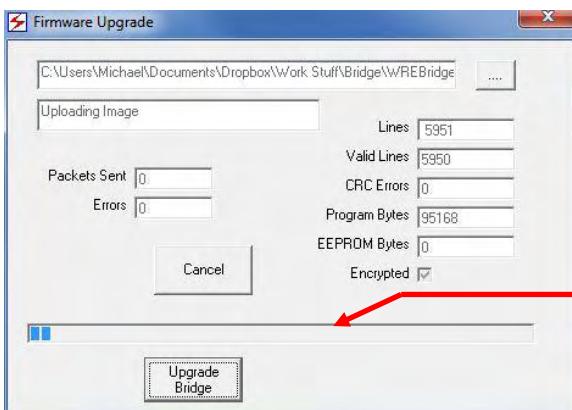

The Upgrade will take 4 to 5 minutes during which the progress bar will run through twice.

Do not tamper with the Rako system whilst the upgrade is occurring

Appendix 1: How to discover House and room numbers by looking at wall plates

Look at Control Panel (Wall Plate) to discover House and Room settings



Unscrew and remove Front from Wall plate

Note: Other versions and models of room controllers also exist. Construction of these is different, but the way in which House and Room setting are done is the same.

Pry rear cover from wall plate by pulling at position marked above



Inspect 'House' and 'Room' settings

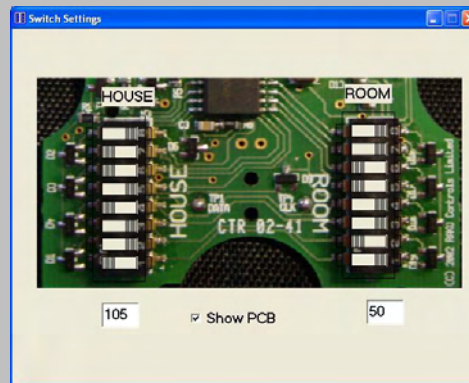

Rasoft can be used to decode the settings into House number and Room numbers.

In Rasoft go to 'Help', then 'Switch Settings'

Move the On-Screen switches to match those of the wall plate to see the House and Room numbers. In the example above, the House address is 105 and the Room number is 50

(Normally, all room controllers will have same House Address,

Appendix 2: Configuring a Rasoft file to work with Smart Phone

Discover House and Room Numbers

It is first necessary to find out the House and Room addresses of each control panel. To do this each one needs to be removed from the wall and it's address switches examined. The address numbering is binary coded, this can be translated into decimal using Rasoft . See appendix 2 for more detail.

Make notes of the Room Number and Location of each Control Panel.

A list like this will contain the information that you need:

Location	Room Number
Dining room	6
Kitchen	8
Outside Lights	13
Master Bedroom	11
Bedroom 2	12
Etc etc

Some rooms may contain multiple control plates with same settings as each other. This is normal. You only need to record one of them.

Enter Room Numbers into Rasoft

When there is a complete list of Room Controllers the information can be entered into a RASOFT File.

If the House address has not yet been programmed into the APR Bridge, then do so now. Follow steps 1 & 2 on Pages 2 & 3 of this document.

Run the Rako Lighting program on a PC or Laptop.

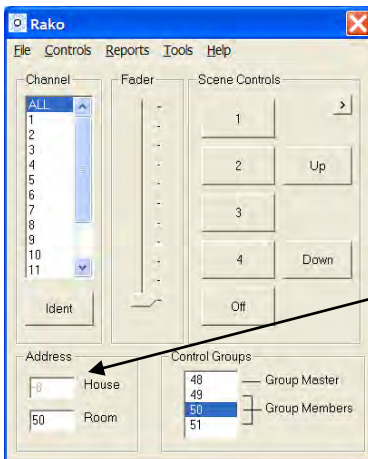

Rasoft start up screen

House number is greyed out when using Rasoft with WTC-Bridge

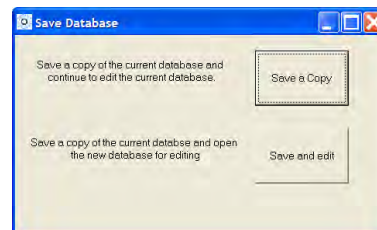

From the start up screen select 'Save' from the File menu then choose 'Save and edit'.

This creates a new project file, leaving the original blank for use later if further projects are planned.

Any changes made to the project file are saved live and do not need to be saved at the end of programming.

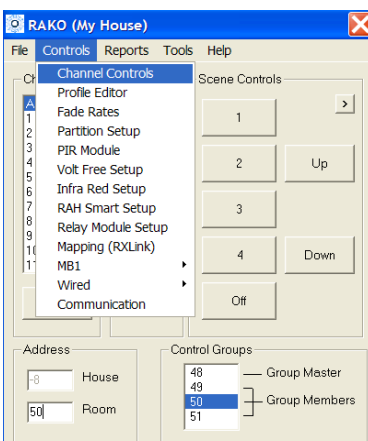

Select 'Channel Controls' to begin entering the room numbers.

Use the 'Add' button in the bottom right hand corner of the Channel Control window to create rooms. Number them according to the address switches of the panels within the rooms.

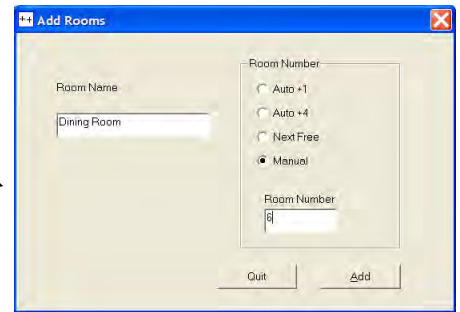
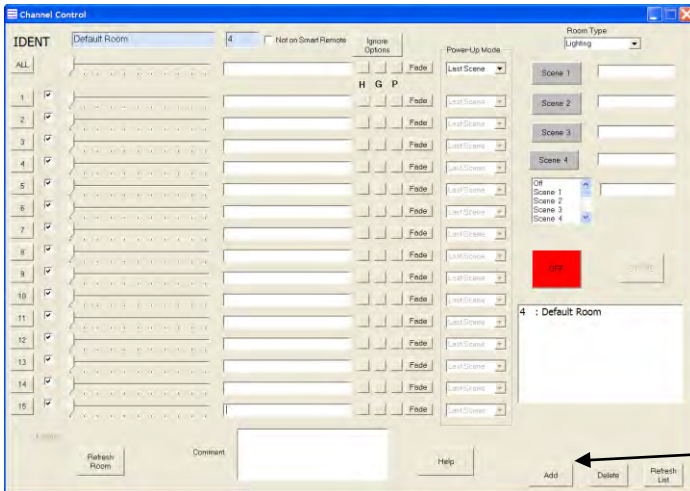

Type in the Room Names and Room Numbers from the list made earlier.

'Add'

When the rooms have been added they will show as a list in the bottom right hand corner of the Channel Control window.

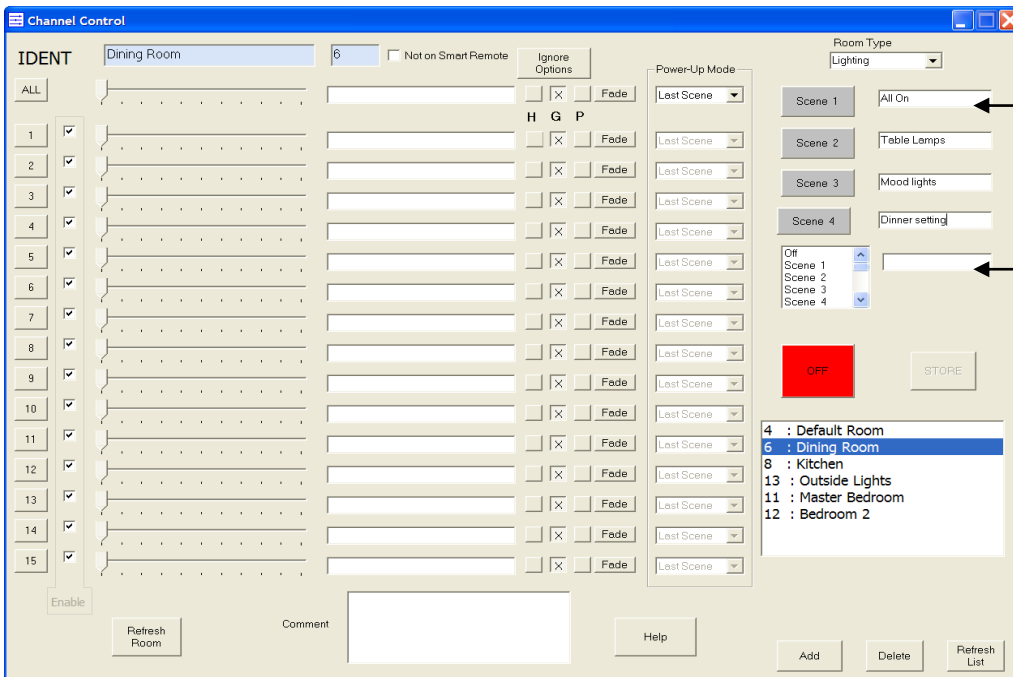

Give Scenes Names

Delete the Default Room 4.
Or rename it if it being used

For each room the scenes 1 to 4 can be given a descriptive name.

Enter Channel Names into Rasoft

As well as allowing selection of Rooms and Scenes, the iPhone Application can control individual circuits within the house. To do this properly the channels in each room must be identified.

At the Left hand side of the Channel control window, press the Channel 1 Ident Button and observe which lights flash on & off in the room. Type a description of these lights in the Channel 1 description. Tick the Enable box for that channel.

Repeat for each channel in all rooms until all lights have been identified.

Any channels that are not being used (i.e. no lights flash when the Ident button is pressed) should be left with a blank description and the enable box should be un-ticked.

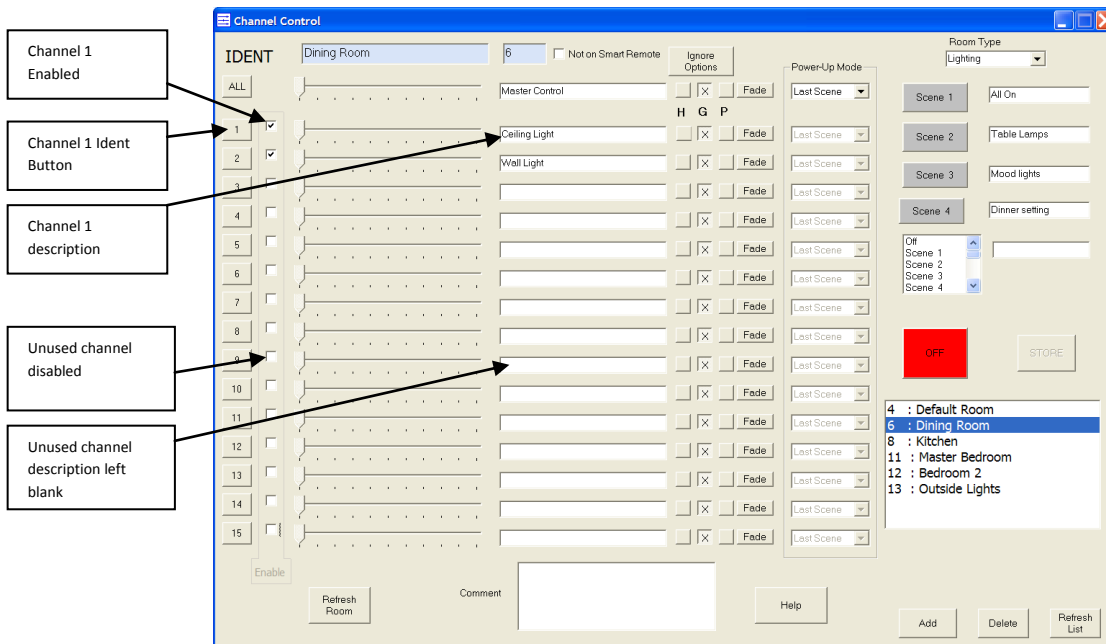

Select which rooms and circuits should appear in the iPhone application

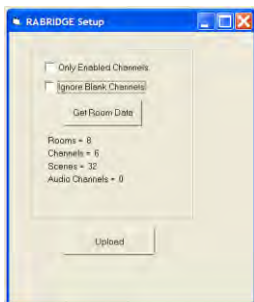

The *Rabridge Setup* utility has two check boxes. These are used to prevent the iPhone application being clogged up with unwanted menu items which refer to unused channels. The Bridge can only hold information for 256 channels: Unused channels will quickly exceed this limit if neither of these boxes are ticked.

By ticking 'Only Enabled Channels' the iPhone will only use channels that are ticked as enabled within the Rasoft Channel control window.

By ticking 'Ignore Blank Channels' the iPhone will only use channels that have been given proper descriptive names.

In addition, an entire room can be omitted from the iPhone. To do this, simply tick the "Not on Smart Remote" box at the top of the Channel control screen.

Technical Support

For more information contact Rako Controls Ltd 01634 226666 www.rakocontrols.com