

# Three button Mounted Switch RPS03-\*\* Installation, Programming and Operating Instructions.

## General

The rako three button control panels are designed for use with the Rako RACUB motor control units only with raise lower and stop functions.

Rako switches are designed to cope with a number of different installation situations.

These are predominantly:

Flush fixing into a UK back-box.

Surface mounting with a UK back-box

Surface mounting with no back-box or onto a European DIN standard or French box.

In order to fit successfully into all the above situations the wall-plate is made from an assembly of parts, all of which are supplied as standard and are listed below. The parts can also be identified from the drawing Fig1. (Note: Depending on the application not all of the parts may be used)

- |  |                              |
|--|------------------------------|
| 1 x Front plate.                                     | 2 x 6mm M3.5 fixing screws.  |
| 1 x PCB retainer (complete with PCB and button pad). | 2 x 25mm M3.5 fixing screws. |
| 1 x Rear cover.                                      | 2 x self-tapping screws.     |
| 1 x Patress.   |                              |
| 1 x Universal backing plate.                         |                              |

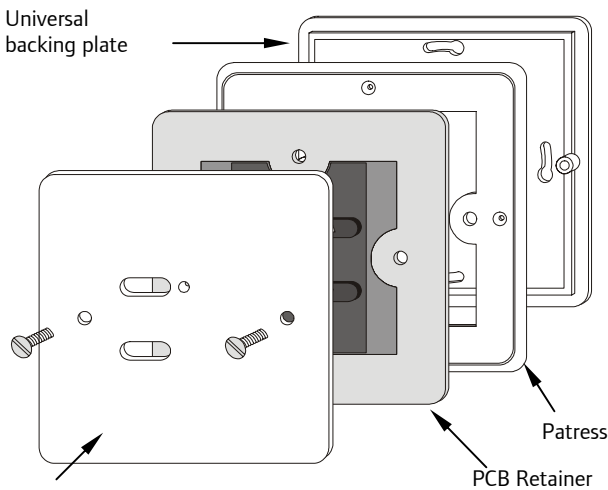

**Fig 1. Front View of Components**

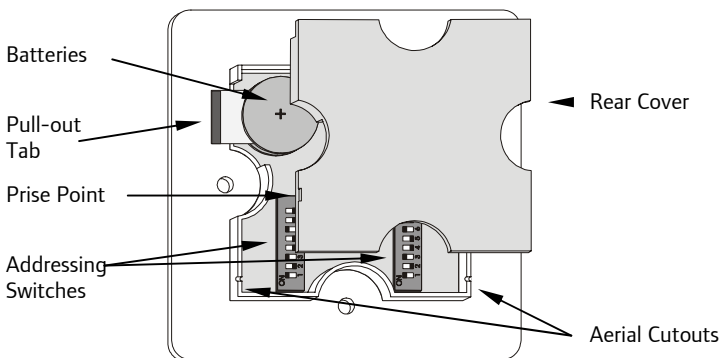

**Fig 2. Rear View of PCB Retainer and Rear Cover**

## Setting Up and Addressing the Units

### Important

**This section must be read and followed before installation of the Rako wall switch.**

Rako wall mounted switches are supplied with a pullout tab to prevent inadvertent operation and battery deterioration during transit. To remove this and to access the address switches remove the rear cover.

### Rear cover removal.

Insert the tip of a small screwdriver or similar into the prise point (Fig. 2) and gently lift off the rear cover. This should expose the battery compartment and addressing switches. Care should be taken not to touch or otherwise damage any of the exposed electronic components.

### Checking for correct operation

With the rear cover removed pull out the tab protecting the batteries (see Fig.2); the Rako wall switch should now be operational. To check this press one of the buttons on the front of the PCB retainer and the indicating LED should illuminate briefly for a single flash. If the LED does not flash or it flashes repeatedly for a short burst (low battery warning) then you should contact your Rako dealer.

### Set-up and Addressing

To avoid interference between adjacent rooms of a house and neighbouring houses as well as allowing individual control of separate curtains/blinds within a room rako radio controllers employ a structured addressing system.

Rako radio systems use a structure based on house, room and channel addresses. Using the two banks of DIL switches on the back of a wall panel or hand control (see Fig.3) a House address can be selected from one of up to 255 possible addresses and a Room address from one of up to 255 possible addresses.

### Note

**House 0 is not a valid address and Room 0 is a special address which gives overall control for a whole house. Room 0 should not be selected as a Room address without careful thought regarding the application.**

Setting an address is the way in which interference between other Radio Controlled Radio systems, either with other rooms within your house or neighbouring houses, is avoided. It should be remembered that a Rako transmitter may have a range of over 100m.

Rako controllers come set with a default address of House 1, Room 4, Channel 1 and whilst the unit will function with this address it is strongly advised that a specific and logical address for both House and Room be selected

Modules can be given channel addresses from 1-8 allowing control from the 7 button wall-plates and hand-held controllers.

Some advanced grouping arrangements are possible allowing banks of modules to be controlled as groups within a room. Systems with advanced programming need to be factory set. For more details contact Rako.

### Setting an Address

Each Rako transmitter has two, 8 way banks of switches for setting its address. The two sets of switches allow the user to choose from 255 house addresses and 255 room addresses. To set the address, remove the rear cover (refer to controller manual for details), whereupon the banks of switches will now become visible. To set an address, use a small

terminal screwdriver or similar device and carefully move some of the switches into the 'ON' position. Addressing uses binary encoding and the value of the switches is shown below.



**Fig 3.**  
**Addressing Switches**

Once the addresses have been set it is strongly recommended to keep a note of the settings and to keep these in safe place. Whilst it is easy to set the addresses, those of the receiver units are normally only set once. To do so requires access to the units and once set these may be installed in inaccessible positions. If, therefore the wall-plate address get changed for any reason and the original settings cannot be remembered then access to the receiver units will be needed for reconfiguration.

**Setting receiver addresses.**

Once a House and Room number have been selected on a control panel these need to be transmitted to each receiving module along with a valid channel number. This is done by one of two methods using a Rako wall switch , hand-held transmitter or Rako software RASOFT .

To send an address to a receiver unit, the unit needs to be put into receive mode. To do this hold the magnet provided against the side casing in the position indicated by the label and as shown below.

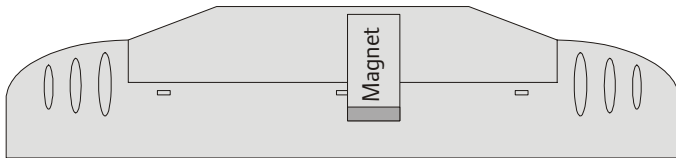

**Fig 4. Set-up Magnet Positioning**

Once the magnet is in the correct position an internal LED will illuminate. If the magnet is held in position for approximately 5 seconds the LED will start to flash, this flashing indicates that the module is ready to receive an address from a transmitter.

**Sending an address from a single channel transmitter**

From either a Rako single channel wall switch or hand-held transmitter (both are functionally identical) press and hold both raise lower buttons for 5 seconds. After 5 seconds the unit will automatically send a channel 1 address. The red LED on the transmitter will flash to confirm that this has been sent. As soon as the receiver gets a valid address it automatically drops out of set-up mode. To set other channel addresses from 2 -15 RASOFT programming software is required

**Note**

If a receiving unit, in set-up mode, does not receive a valid address within 3 minutes the receiver will automatically drop out of set-up mode.

**Setting an address from a single channel wall switch**

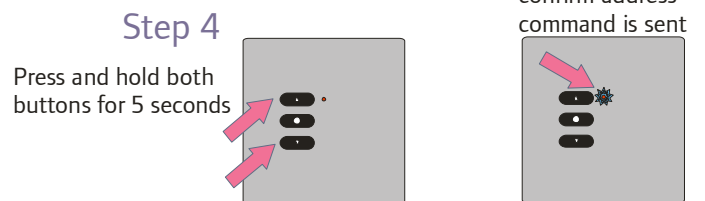
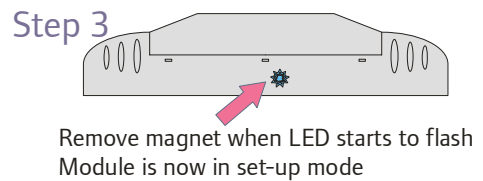
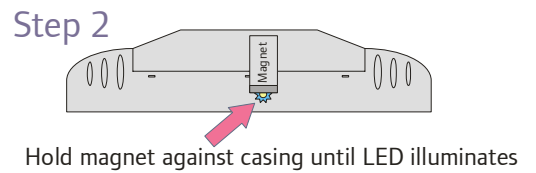
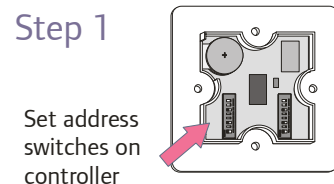

## Operation

### Single Channel Transmitters

Single channel transmitters only allow simultaneous control of all channels in a room.

## Installation

Before assembly ensure that the rear cover is firmly fixed and that the aerial is positioned in a way as to not foul other components.

### Warning

**Rako wall-switches are designed to operate at safety extra low voltages (6V). When fixing the wall-plates to existing back-boxes there may be mains wiring present, if this is the case then the wiring should be made safe, properly insulated and any metal back-boxes earthed. Earthing of the back box is essential if a decorative metal front plate is being used. Should there be any doubt in how to do this contact a qualified electrician.**

**Rako Ltd accepts no responsibility for any damage or injury caused by incorrect installation of a Rako product.**

### Surface fixing to UK back box.

Orientate the patress so that the bossed inserts are aligned vertically and locate the PCB retainer in the patress. Then using the 25mm fixing screws fix the front plate to the retainer and patress and back-box.

### Flush fixing to a UK back-box

Fit the PCB retainer in the back-box so that the clear flange is flush to the wall. Then using the 12mm fixing screws (or 25mm if needed) secure the front plate to the PCB retainer and back-box.

Note. Transmission range is greatly enhanced if the aerial can be positioned outside of the back-box. This is because the front plate and back-box will form a 'Faraday cage', which will give very poor radio transmitting conditions. To position the aerial correctly a hole must be cut in the back-box and a small diameter hole drilled into the wall. Straighten the aerial and push the aerial into the hole. The best radio transmission will be achieved when all of the aerial fully extended and outside of the back-box. If, because of physical constraints, it is not possible to drill the hole in a position close to where the aerial emerges from the PCB retainer, then the rear cover can be removed and the aerial re-positioned in a more convenient aerial cut-out (see fig 2).

### Surface fixing with no back-box

Take the universal backing plate and screw this to the wall (screws not included) using the fixing slots. Rotate the patress so that the bossed inserts are aligned horizontally and then, using the 2 x self-tapping screws, fix the patress to the universal backing plate taking sure not to over-tighten the screws. Insert the PCB retainer into the patress and then using the 2 x 6mm fixing screws, secure the front plate to the patress fixing the screws through the PCB retainer and into the bossed inserts.

### Surface fixing to European back-boxes.

For fixing to European DIN or French standard back-boxes the Rako universal backing plate has been designed so that two of the fixing slots match European DIN standard back-box fixings and two match standard French back-box fixings. To mount the assembly, orientate and mount the universal backing plate as applicable (screws not provided) and then follow the instructions for 'Surface fixing with no back-box'.

## Care and maintenance

### Battery replacement

The Rako series of wall-switches are designed to be powered by batteries. The designed battery life is better than 3 years (based on 30 button presses daily) but the batteries will eventually need replacing. In normal use the LED on the front panel illuminates momentarily when a button is pressed to indicate that a (radio) transmission has been made. When the batteries are approaching the end of their useful life the LED will continue to blink after a button has been pressed. When this starts to happen the batteries should be replaced as soon as possible.

### **Always use two CR2016 type batteries.**

To replace the batteries unscrew the front plate and remove the PCB retainer, taking care not to damage the aerial (note that when flush mounted the aerial may be located in a hole outside the back-box). Remove the rear cover and carefully slide out the batteries. Replace with new batteries ensuring that the positive (+) terminal makes contact with the battery clip and the negative (-) terminal with the pad on the circuit board.

To ensure reliable operation always ensure that battery contacts and battery surfaces are kept clean of any grease, moisture or other contamination.

### Warning

**Lithium batteries may explode if handled incorrectly. Always dispose of used batteries in accordance with manufacturer's recommendations.**

### NOTE

Early Versions of the RACUB are set up for Scene Setting Latching mode and may need to be reprogrammed using RASOFT to pulsing mode.

Rako thanks you for having purchased a Rako product and hopes that you are pleased with your system. Should for any reason you need to contact us please contact us via our website [www.rakocontrols.com](http://www.rakocontrols.com) or by phoning our customer help line on 01634 226666